

## LT VERSION

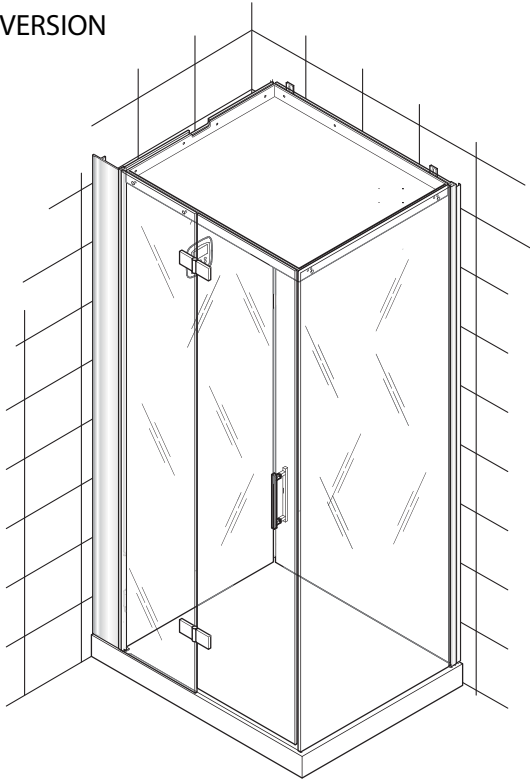

VERSION IN LEFT CORNER

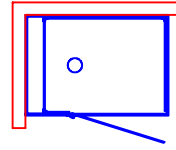

VERSION RIGHT CORNER

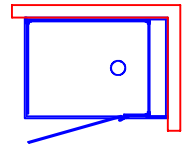

VERSION IN LEFT CORNER

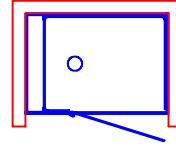

VERSION RIGHT CORNER

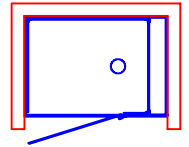

Aversion to WALL  
With side door LINKS

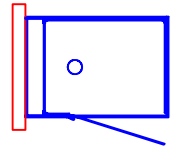

Aversion to WALL  
With side door RIGHT

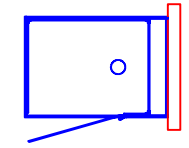

Aversion to WALL  
WITH CENTRAL DOOR LEFT

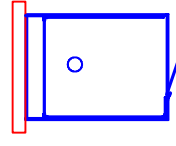

Aversion to WALL  
WITH CENTRAL DOOR RIGHT

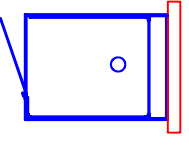

The minimum height of the wall tiles without protrusions is equal to the height of the stall.  
On the walls there cannot be any greca or quarter round decorative patterns.

SYSTEMS	Electrical characteristics				Hydraulic characteristics					Overall dimensions				
	Volts	A	Kw	Hz	max	working	water	connections		stall package dimensions			weight	
					water consumption	pressure	jets	H/C water	discharge	length	width	height	net	gross
<b>INTEGRA JUNIOR</b>	230	9.1	2	50	20 l/min 20 l/min	1,5/4,5 1,5/4,5	6 6	1/2" 1/2"	40 40	219 219	73 73	114 114	105 105	135 135

The electrical characteristics should only to be considered in models with a Turkish bath.

The overall dimension values are expressed in centimetres. The actual dimensions may vary by ± 1 cm.

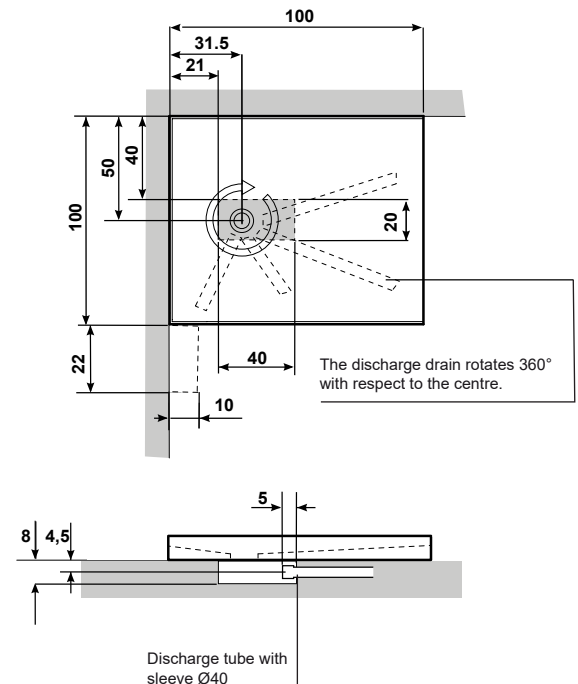
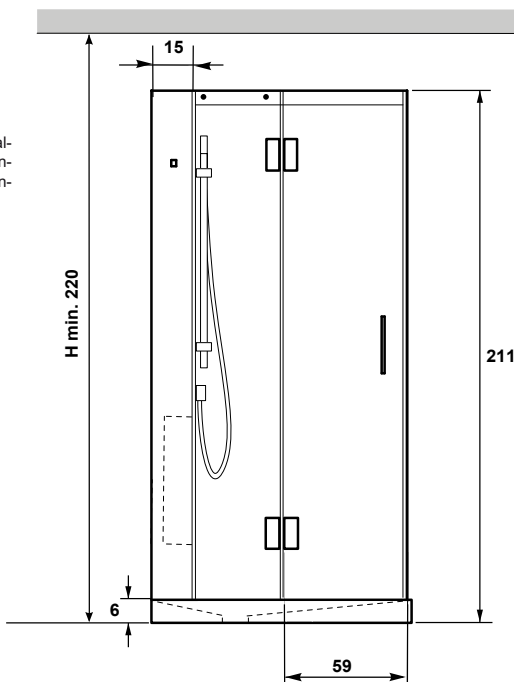

## LT VERSION

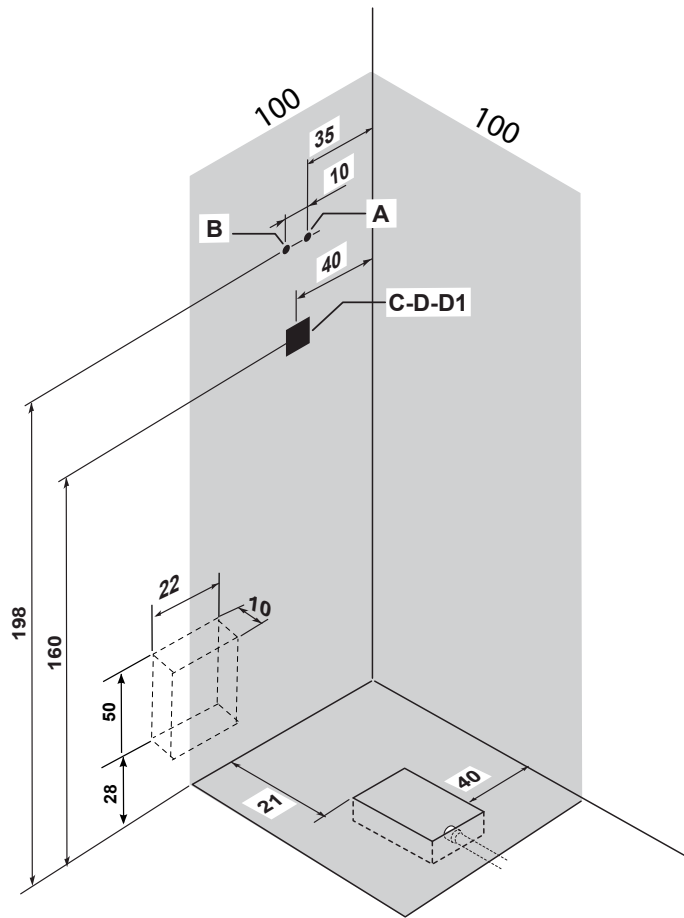

## RT VERSION

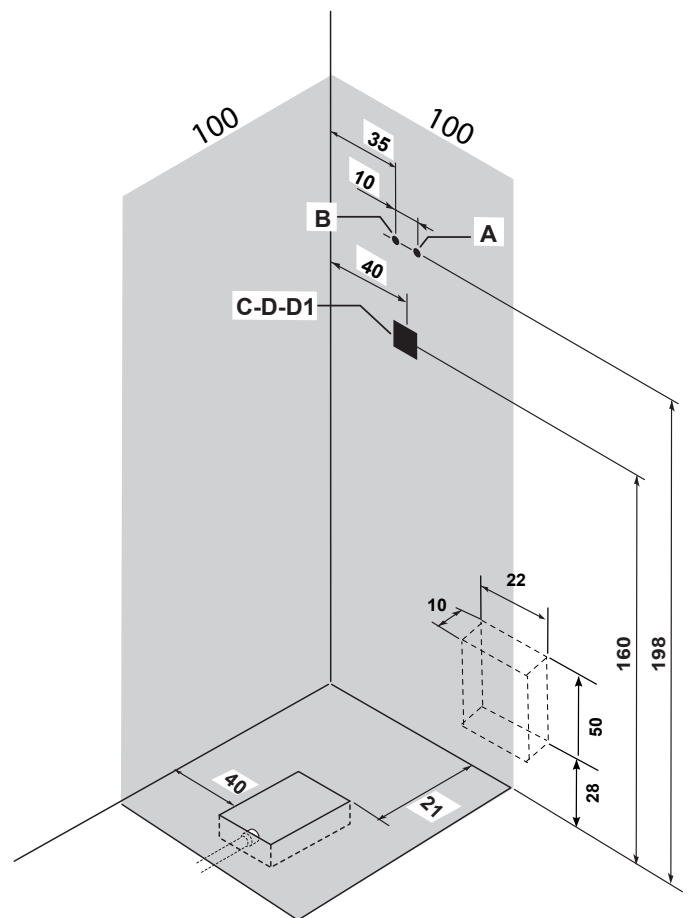

## LEGEND

**A** - F cold water wall connection

**B** - F hot water wall connection

**C-D-D1 electrical tube outlet**



**C** - Power cable outlet ( min. length 2 [m] )

**D** - Equipotential cable outlet ( min. length 2 [m] )

**D1** - Emergency cable outlet ( minimum length 2 [m] )

Connections C and D1 should only be considered in models with a Turkish bath.

If the water pressure is higher than indicated, install pressure reducers.

	Operating pressure:
	- MIN 150 kPa (1,5 bar)
	- MAX 300 kPa (3,0 bar)
	Hot water temperature:
	- MAX 60°C (140°F)

Provide shut-off cocks out of the dimensions of the product for hot and cold water closing.

The stall must be installed by personnel qualified in both electrical and hydraulic connections.

Before making the connections, the installer must verify that the electrical system is protected by a differential switch (0.03 A) and that the earthing system complies with regulations in force in the county of use.

The stall must be connected to the electrical system in a fixed manner (with a 3-pole H05 -3x2.5 mm<sup>2</sup> cable with 2.5 mm<sup>2</sup> diameter) using a bipolar switch (minimum contact opening 3 mm.) suitable to the power (KW) of the product to be connected and located outside zones 0,1,2,3 and far from any possible water sprays.

The product must also be connected to the building's equipotential system using the terminal located on the external frame. It is necessary that the stall be able to be moved at any time without having to damage the walls.

**WARNING:** if the conditions indicated are not observed, the safety of the stall may be compromised: in this case, the product guarantee and the manufacturer's responsibility for any direct or indirect damage cause by the product shall be void.

When the guarantee is voided, for the above-mentioned reason, only parts recognised as being defective will be replaced and costs related to the labour necessary for product removal will not be covered.